



DL4S  
Data sheet

# DL4S

---

The DL4S is a DESKLINE® lifting column. The column is an optimum choice for a wide range of desk applications especially within the office area. The hallmarks of the DL4S are the 3-stage inline design meaning that the motor is hidden inside the profiles giving the column a very sleek and elegant design easy to integrate in various desk designs. The 3-stage construction ensures a very low built-in dimension meaning that people of all heights can use the desk. The very low noise level ensures pleasant use when driving.



---

## Features:

- Max. thrust 700 N per column
- Max speed: 38 mm/s unloaded
- Standard installation dimension 560 mm
- Standard stroke length 675 mm
- Bending moment: Max. 150 Nm dynamic
- Colour: Black RAL 9005, Grey RAL 9006 or White RAL 9016, all gloss 30
- Low and uniform noise level
- PVC-free column
- Hall sensor (enables parallel drive with control boxes)

## Option

- Bracket for crossbar

## Usage

- Single or 2, 3, 4 parallel drive
- Multi-parallel is possible only when in combination with CBD6S
- Duty cycle: 10% ~ 2 minutes of continuous use at full load, followed by 18 minutes of pause
- Ambient temperature: +5° to +40°C
- Storage and transport temperature -10°C to +70°C
- Compatible with DESKLINE control boxes and all DESKLINE® desk panels
- Approved according to EN60335-1 and UL 962 with CBD6S

**Technical specifications:**

Type	Max. Thrust pr. DL (N)	Self-lock pr. DL (N)	Speed at 0 load (mm/s)	Duty cycle (%)	Spindle pitch (mm)	Stroke length (mm)	Built-in length (mm)
DL4S	700	700	38	10	20	675	560

The measurements above are made in connection with control box CBD6S.

**Dimensions**

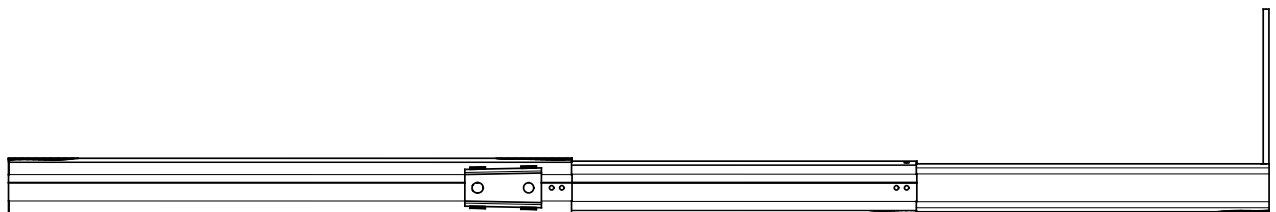
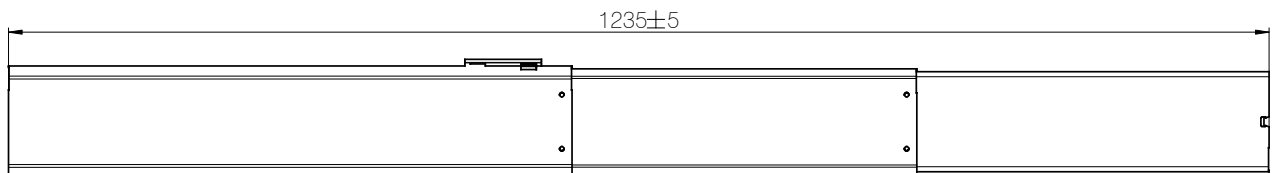
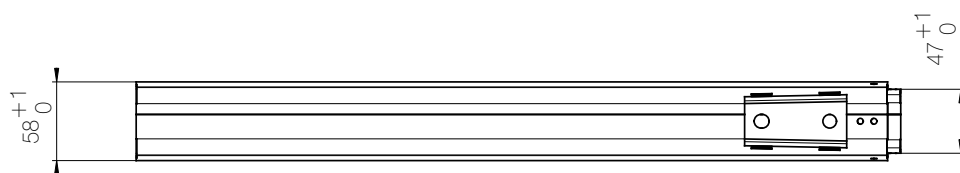
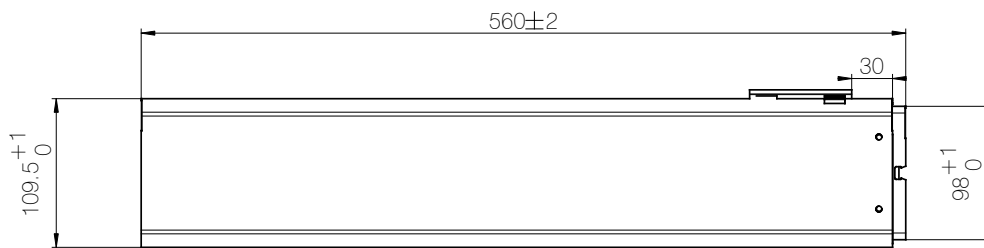
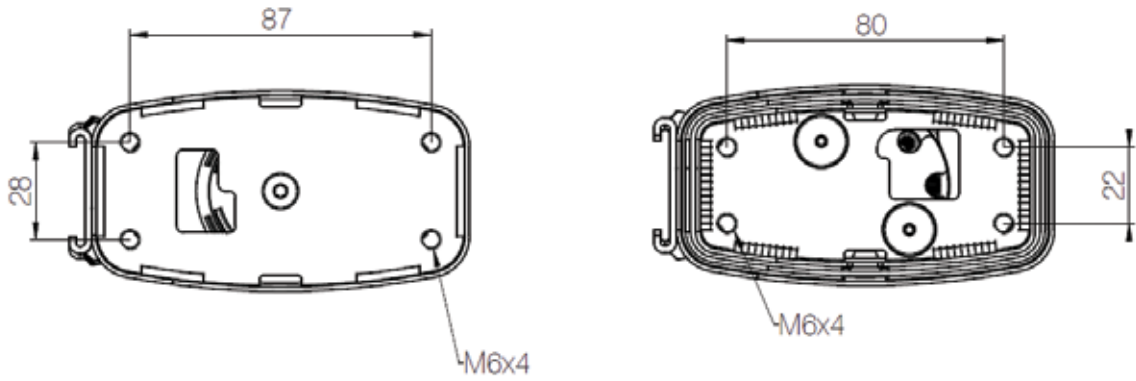

Curves for DL45

2 x DL45 (equally loaded) with CBD6S

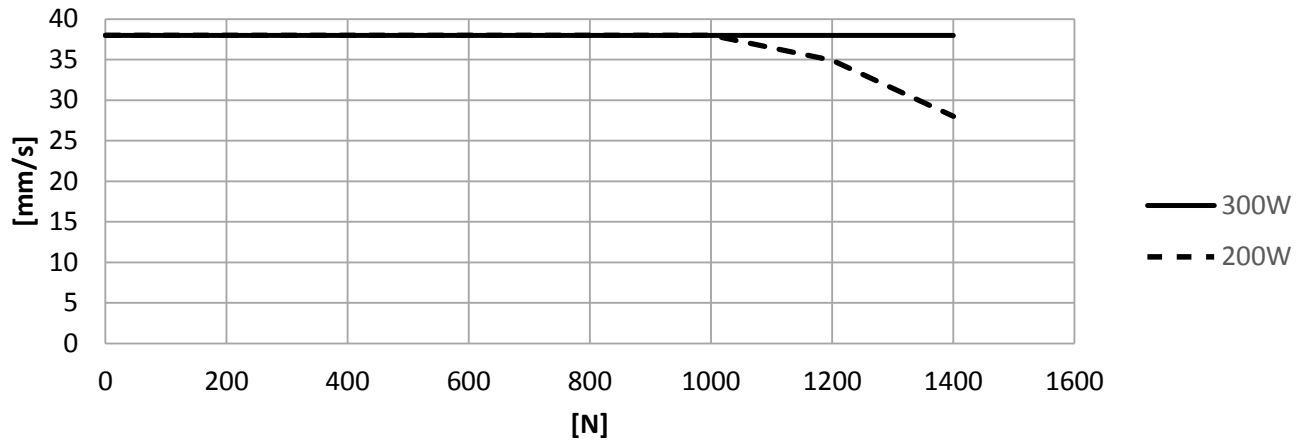

3 x DL45 (equally loaded) with CBD6S (300W)

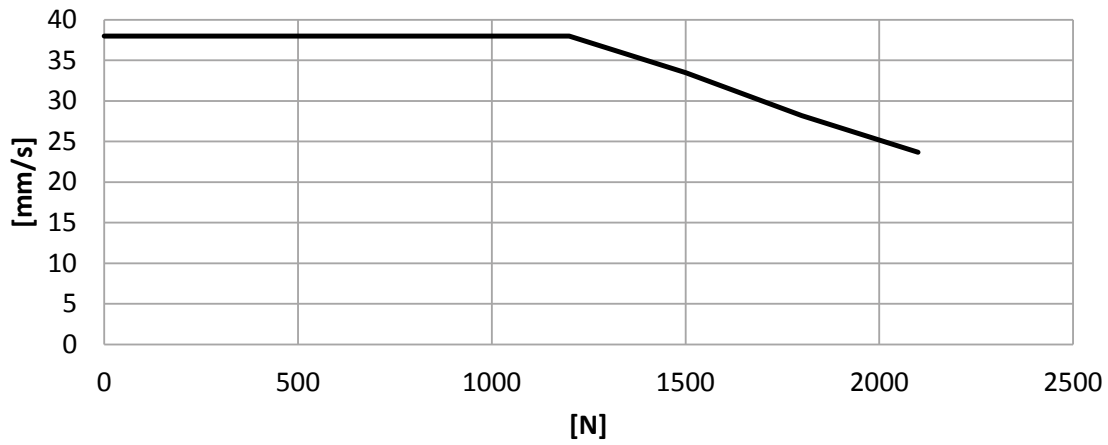

4 x DL45 (equally loaded) with CBD6S (300W)

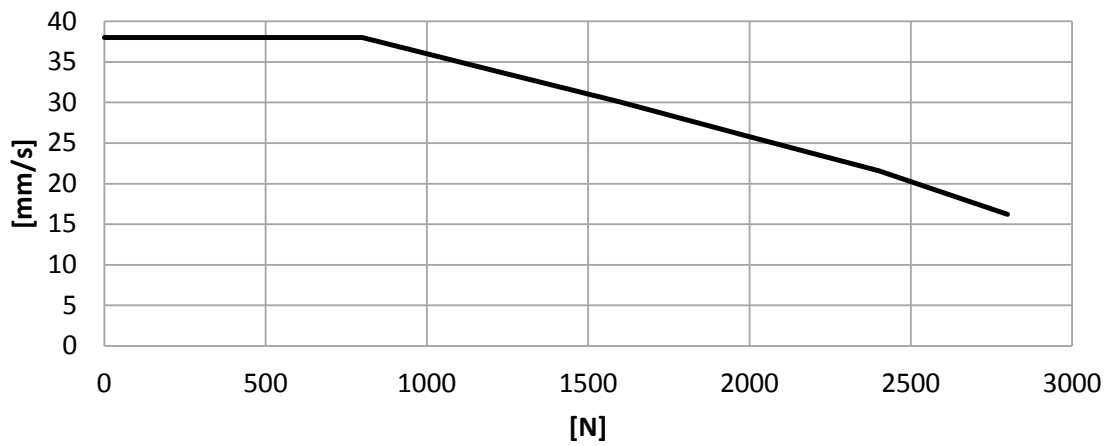

## DL4S

### Ordering example:

<b>DL4S</b>	<b>0</b>	<b>0</b>	<b>1</b>	<b>B</b>	<b>0</b>	<b>0</b>	<b>675</b>	<b>560</b>	
									<b>Installation dim. :</b> 560 mm
									<b>Stroke length:</b> 675 mm
									<b>Motor type:</b> 0 = Standard
									<b>Option:</b> 0 = Standard
									<b>Colour:</b> A = Grey (RAL 9006 G30) B = Black (RAL 9005 G30) D = White (RAL 9016 G30)
									<b>Mounting bracket:</b> 0 = None 1 = Standard
									<b>Option:</b> 0 = Standard
									<b>Spindle type:</b> 0 = Standard
									<b>Actuator type:</b> DL4S



All cables for creating a fully connected DESKLINE system must be ordered separately. We offer a range of different versions and lengths. For more information as ordering number, colour and length of the cables, please contact your local LINAK.

Ordering number for crossbar brackets (box containing 100 pcs.): 0611871





---

**Terms of use**

The user is responsible for determining the suitability of LINAK products for specific application. LINAK takes great care in providing accurate and up-to-date information on its products.

However, due to continuous development in order to improve its products, LINAK products are subject to frequent modifications and changes without prior notice. Therefore, LINAK cannot guarantee the correct and actual status of said information on its products.

While LINAK uses its best efforts to fulfill orders, LINAK cannot, for the same reasons as mentioned above, guarantee the availability of any particular product. Therefore, LINAK reserves the right to discontinue the sale of any product displayed on its website or listed in its catalogues or other written material drawn up by LINAK.

All sales are subject to the Standard Terms of Sale and Delivery for LINAK. For a copy hereof, please contact LINAK.